

CONNECTION SCHEDULE						
ITEM	DESCRIPTION	LOCATION	MAX. FLOW	SIZE	CONNECTION	MATERIAL
A	RAW WATER INLET	R.O. SKID	17.4 GPM	1"	150# FLANGE RF	PVC SCH 80
B	PERMEATE OUTLET	R.O. SKID	11.3 GPM	1"	150# FLANGE RF	PVC SCH 80
C	CONCENTRATE OUTLET	R.O. SKID	6.1 GPM	3/4"	150# FLANGE RF	PVC SCH 80

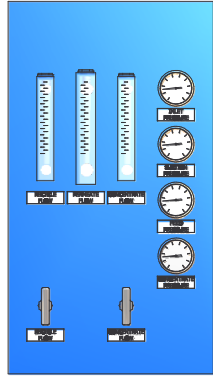

MRO PANEL VIEW

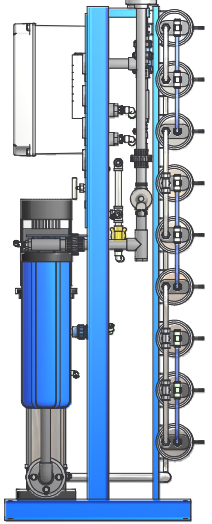
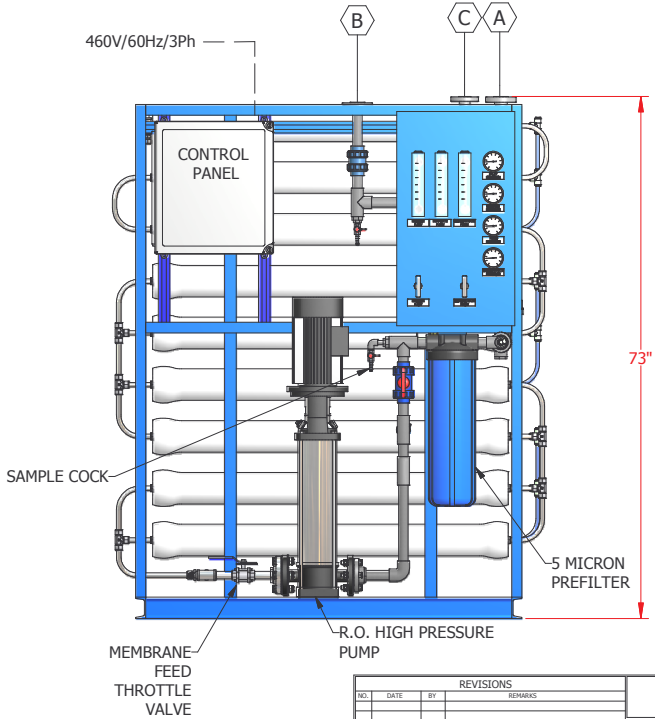
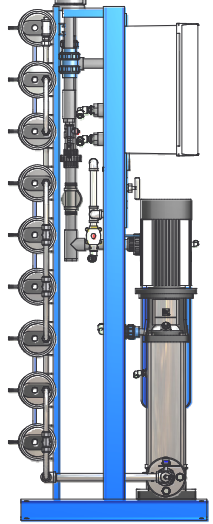
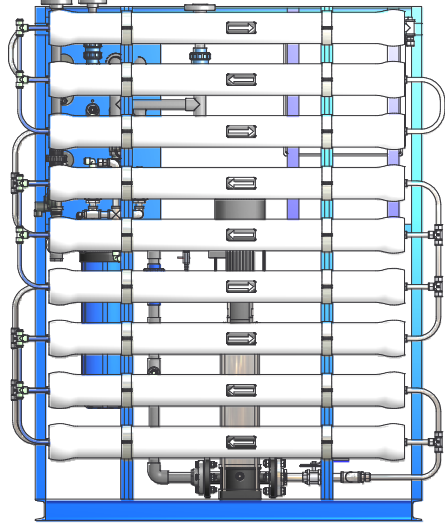
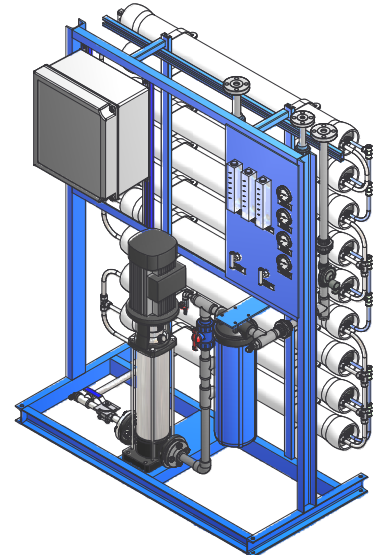
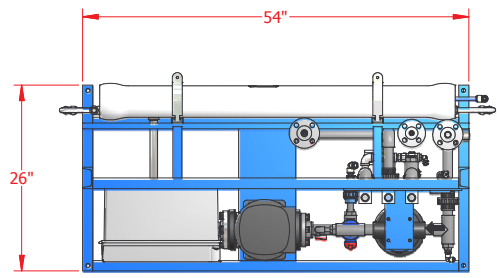

REVISIONS		
NO.	DATE	REMARKS

NRO-16200-4H RESERVE OSMOSIS GENERAL ARRANGEMENT			
FRAC. #	DEC. #	FILE ID.	SCALE

8 7 6 5 4 4 3 2 1